

ZIGEN

User Manual



Matrix Switcher

HDMI 8x8

HX-88

V.2011HX88.00

Copyright and Trademarks:

All rights reserved by ZIGEN INC. No part of this document may be reproduced in any form or by any means without written permission from the product manufacturer. Changes are periodically made to the information in this document. They will be incorporated in subsequent editions. The product manufacturer may make improvements and /or changes in the product described in this document at any time.

All the registered trademarks referred to this manual are belonging to their respective companies.

Before You Begin

- Follow all instructions marked on the device during using.
- Do not attempt to maintain the device yourself.
- Provide proper ventilation and air circulation and do not use near water.
- The system should be installed indoor only. Install either on a sturdy rack or desk in a well-ventilated place.
- Do not use liquid cleaners to clean the device.
- Always unplug the power to the device before cleaning.
- Unplug the power cord during lightning or after a prolonged period of non-use to avoid damage to equipment.

Table of Contents

1.0 Matrix System Overview	4
1.0.1 Introduction	4
1.0.2 Packing	5
2.0 Features	5
3.0 Specifications	6
4.0 Host Installation	6
5.0 Front/Rear Panels	7
5.0.1 Front Panel	7
5.0.2 Rear Panel	8
6.0 HDMI Matrix and Peripherals Connection	11
6.0.1 Input/Output Connections	11
6.0.2 HDMI Matrix / Control Computer Connection.....	12
6.0.3 IR2 Connection	15
6.0.4 Power connection	15
7.0 Matrix Application Software	16
7.0.1 Software Introduction.....	16
7.0.1.1 Software Description.....	16
7.0.1.2 Software Activation.....	16
7.0.2 RS-232 Software Configuration.....	17
7.0.2.1 RS-232 Main Operation Interface	18
7.0.2.2 Disconnect Function Keys	20
7.0.2.3 Select all output, DeSelect all output Switching Functions	21
7.0.2.4 Disconnect all Command	22
7.0.2.5 RS-232 Memory Function.....	22
7.0.2.6 Options Function	23
7.0.2.7 Other Application	23
7.0.2.8 Communication Protocol/Control Command Code	23
7.0.3 LAN Web Configuration	24
7.0.3.1 LAN Main Operation Interface	25
7.0.3.2 LAN Memory Function.....	26
7.0.3.3 LAN IP Function	27
7.0.3.4 Other Application	28
8.0 Operation Examples	29
9.0 Troubleshooting.....	32
Appendix A Command List.....	Error! Bookmark not defined.

1.0 Matrix System Overview

1.0.1 Introduction











ZIGEN HX-88 Matrix Switcher is high performance HDMI matrix switcher designed for applications where routing of high resolution digital video signals are required. HX-88 Matrix switch is HDMI 1.3c compatible and supports resolutions up to 1920x1200 and HDTV 1080p/60, HX-88 also ensures simultaneous distribution of any input source signal to one or more compliant displays.(one-to-one / one-to-many combination) HX-88 matrix switchers are ideal for use in bars, restaurants, commercial, medical, military, government, and residential environments where distribution of high resolution, digital video signals are needed and digital pathway is essential for maintaining the highest possible image quality from all sources.

HX-88 also offers you the ability to save 8 frequently used I/O configurations as presets. HX-88 can be operated via the front panel, RS-232 serial control, IR and Ethernet control.



Figure 1-1 HX-88 Matrix Switcher

1.0.2 Packing

	HDMI Matrix Host
	RS-232 Communication Connecting Cable
	Power Cord
	IR Extended Line
	LAN Line
	Controller
	2 pcs of AAA battery
	HDMI Matrix Software CD
	User Manual
	6 Screws (for Brackets)

2.0 Features

- HDMI 1.3c Compatible
- 3D support
- HDCP Compliant
- Supports RS-232 / Ethernet control
- Supports IR control
- Internal universal power supply
- 1U rack
- Available in 8x8 fixed I/O interfaces.
- Built-in Daughter Card (Board) Interfaces (LAN card included)

- Supports computer video up to 1920*1200
- Supports HDTV up to 1080p/60
- EDID management (Copy from OUT port 1)

3.0 Specifications

Function	HX-88
Input Connector	8 x HDMI Type A
Output Connector	8 x HDMI Type A
RS-232 Connector	DB9 Female
LAN Connector	RJ-45
Select Switch	21
LCD Module	1
Max. Resolution	1080P
Highest TMD5 Frequency	225 MHz
HDMI Cable Distance	10 meter (Max.)
Power	100~240VAC, 50~60Hz, internal
Housing	Metal
Weight	2350 g
Dimensions (LxWxH)	440x336x43mm

4.0 Host Installation

The HDMI Series Matrix Host has a black metallic housing. It can be placed on a sturdy desk directly or installed on a 19-in rack. See Figure 4-1 below:



Figure 4-1 Mount the HDMI Matrix Host on a Standard Bracket

5.0 Front/Rear Panels

5.0.1 Front Panel



Figure 5-1 HX-88 Front Panel

The HX-88 Matrix Switching System supports up to 8 Output/Input switching keys on the Front Panel allowing you to switch signals quickly.

Operation method No. 1: “Output Channel” + “Input Channel”

Click the Output button then click the Input button to set the combinations.

Operation method No. 2: “STO or RCL” + “Output Channel”

Click the STO or RCL button then click the Output button.

Operation method No. 3: single operation

This example for EDID button, you can click the EDID button directly.

Operation method No. 4: “STO and RCL” + “Input Channel”

Click the STO and RCL button then click the Input button to set the combinations.

- **OUT1~8 keys** (output channel): Indicate the Channel 1~Channel 8 for HDMI signal output to peripheral display. You can also use these keys to adjust the status or access the settings
- **IN1~8 keys** (input channel): Indicate the Channel 1~Channel 8 for HDMI signal input. You can use these keys to switch to the connection of the connected signal source channels.
- **IR1:** Infrared receiver.
- **All:** This key allows you to set single input channel to all output channels.
 - Press the “**All**” key.
 - Select one of the IN 1~8 keys.
 - The selected **IN x** key will deliver the signal to all output channels.
 - You can also press “**All**” key and then the “**OFF**” key to disable all displays.
- **OFF:** Disable the entire output channels. Press one of the **OUT x** keys that you want to disable.

- **STO:** The “**Store Key**” saves all current input/output corresponding relations.
 - Press the “**STO**” key. (Supports up to 8 sets of memories, you can select the memory location through OUT1~OUT8)
 - Arrange the Output and Input channel combinations (output channel key 1~8).
 - The relation between the Output and Input settings will be saved in the memory permanently.
- **RCL:** The “**Retriever Key**” retrieves the saved input/output corresponding relations.
 - Press the “**RCL**” key.
 - Then make a selection from one of the output channel key 1~8.
 - The system will retrieve the saved input/output status and implement current status switching.
- **EDID:** **FIX** (fix mode) and **TV1** (access the first output channel) selection key.
 - **FIX mode:** The **HX-88** will supply a set of fixed **EDID** values to support up to only 1080P high performance TV.
 - **TV1 mode:** The **HX-88** will access the **EDID** values of high performance TV that is connected to the first output channel, and copy the **EDID** value to all the input channels so that the DVD players and etc can support the same values to all HDTV monitors.
- **LCD:** LCD display shows current HDMI matrix status and operation status.

5.0.2 Rear Panel



Figure 5-2 HX-88 Rear Panel

The HX-88 supports up to 8 input/output connectors on the rear panel, each female terminal forms the signal input/output connectors. The HX-88 signal input/output terminal channels are numbered from right to left as OUT1~4 / IN1~8 / OUT5~8 channels. The input terminal channels supply you to connect to different equipment including DVD players and graphics workstations. The output terminals can be connected to projectors, video recorders, HD displays and etc.

- **Power Port:** The Power Port is applicable for 100~240VAC, 50~60Hz connected to the outlet of power source.
- **Power Switch:** To switch power ON or OFF
- **RS-232:** Use the **RS-232** connection cabel to connect the computer serial port (COM1 or COM2) to the **RS232** communication port of the HDMI matrix host. The computer can then be used to control the HDMI matrix after installation of application software. The RS-232 port is a 9-pin female connector.
- **IR2:** Connect to the IR Extended Receiver.
- **Switcher:**
 - Pin1: Switch between RS-232 port and LAN port connection.
 - Pin2: This Pin allows you to reset the IP value to **192.168.0.3**. The steps are as below:
 - a. Please switch the pin2 down and re-start HX-88.
 - b. After the HX-88 re-starts about 10sec, shut down your equipment.
 - c. Switch the pin2 up, then power on HX-88 again.
 - d. The IP address will be restored to the default value: **192.168.0.3**
 - Pin3: No definition.

Pin #	UP	DOWN
1	LAN	RS-232
2	NORMAL	IP DEFAULT
3	NC	NC

- **LAN Port:** Use the RJ-45 connection cable to connect the Internet and the HDMI matrix host. All PC's in the same network can control the HDMI matrix host through the LAN port.
- **IN1~8:** HDMI input ports are connected to DVDs.
- **OUT1~8:** HDMI output ports are connected to HDTVs.

Daughter board modules:

- MX-HDI1 HDMI Connector input
- MX-HDO1 HDMI Connector output

HDMI Type A Connector pin definition:

Pin #	Signal	Pin #	Signal
1	TMDS Data2+	11	TMDS Clock Shield
2	TMDS Data2 Shield	12	TMDS Clock-
3	TMDS Data2-	13	NC
4	TMDS Data1+	14	NC
5	TMDS Data1 Shield	15	DDC-SCL
6	TMDS Data1-	16	DDC-SDA
7	TMDS Data0+	17	DDC-Ground
8	TMDS Data0 Shield	18	+5V Power
9	TMDS Data0-	19	Hot Plug Detect
10	TMDS Clock+		

6.0 HDMI Matrix and Peripherals Connection

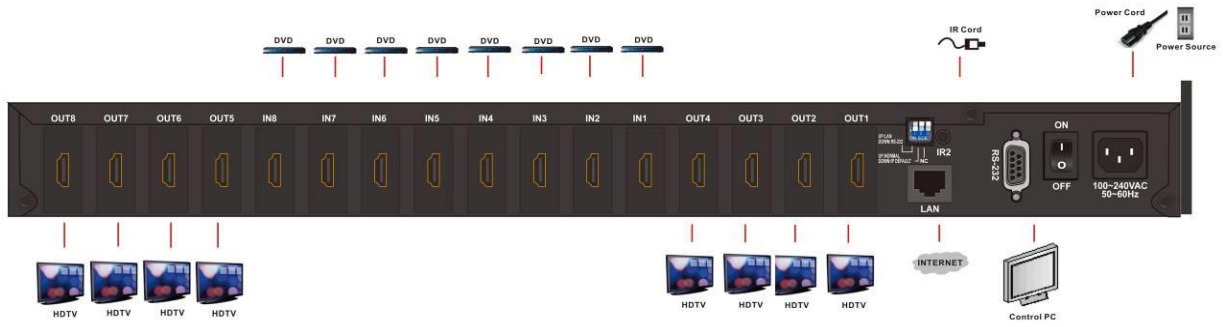

Figure 6-1 HDMI Matrix System Connections

6.0.1 Input/Output Connections

Use the HDMI connecting cable to connect the Input/Output serial port (No.1 ~ No.8) to the HDMI port of the DVD Player/HDTV.

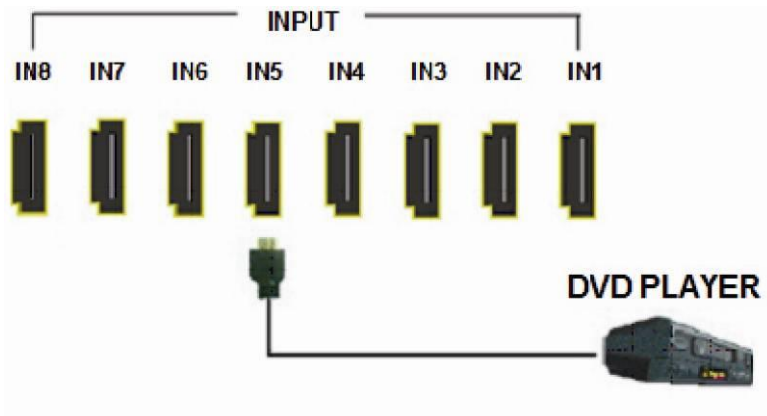

Figure 6-2 Input Connections

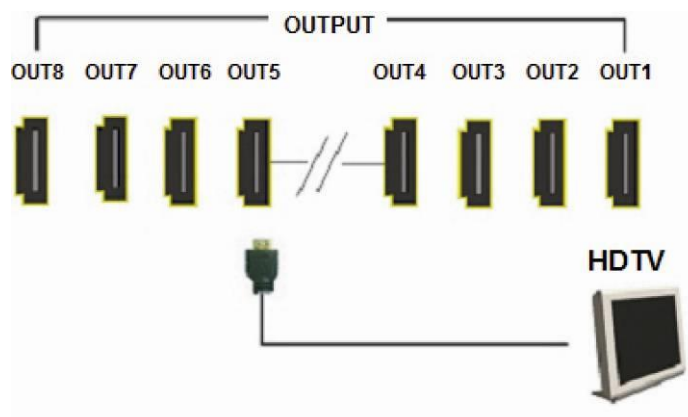

Figure 6-3 Output Connections

6.0.2 HDMI Matrix / Control Computer Connection

Use the RS-232 connecting cable to connect the computer serial port (COM1 or COM2) to the RS-232 communication port of the HDMI matrix host. The computer can then be used to control the HDMI matrix after installation of application software. Aside from using the front panel keys for switching operation, you are also permitted to use the RS-232 connection port for remote operation.

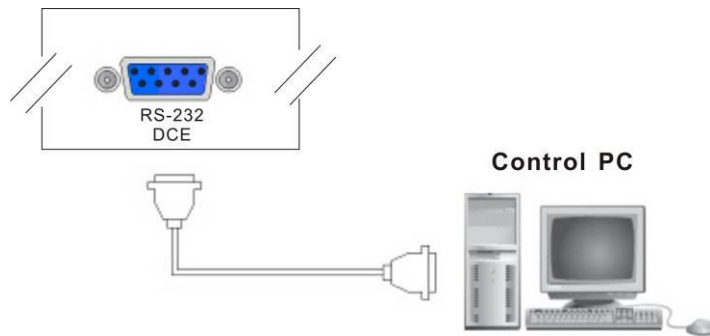

Figure 6-4 (a) RS-232 and Control PC connection

HX-88 also supports a LAN port allows you to control the equipment host through PC Browser.

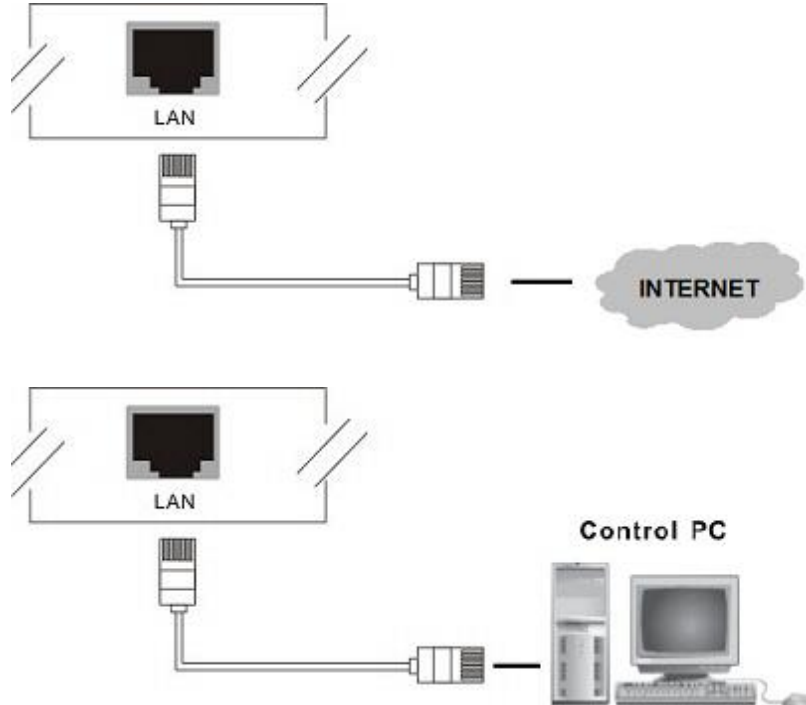

Figure 6-4 (b) LAN port and Control PC Connection

The RS-232 Leg functions are described as below:

Pin No.	Leg	Description
1	N/u	Null
2	Tx	Send
3	Rx	Receive
4	N/u	Null
5	Gnd	Ground
6	N/u	Null
7	N/u	Null
8	N/u	Null
9	N/u	Null

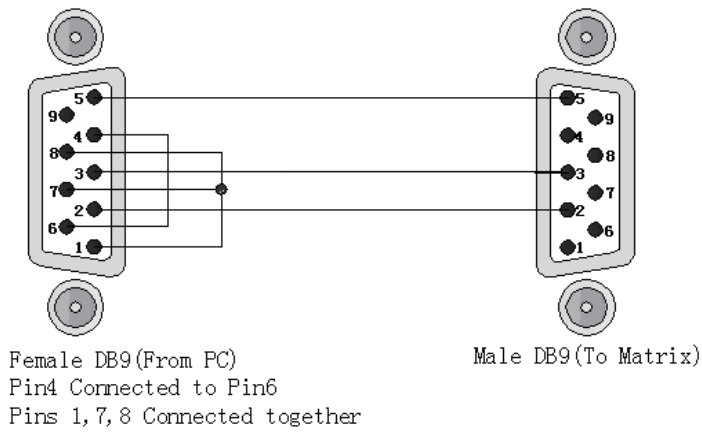

Figure 6-5

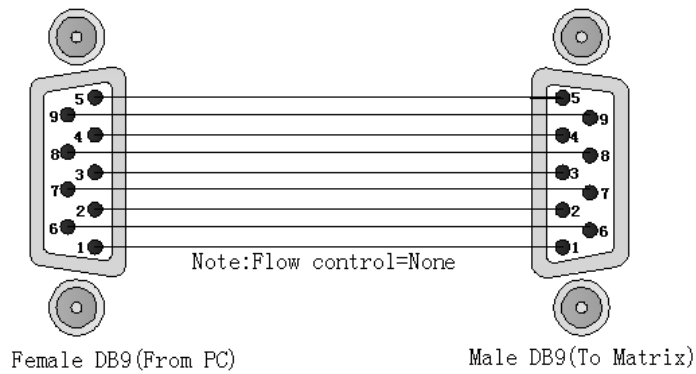

Figure 6-5 (a)

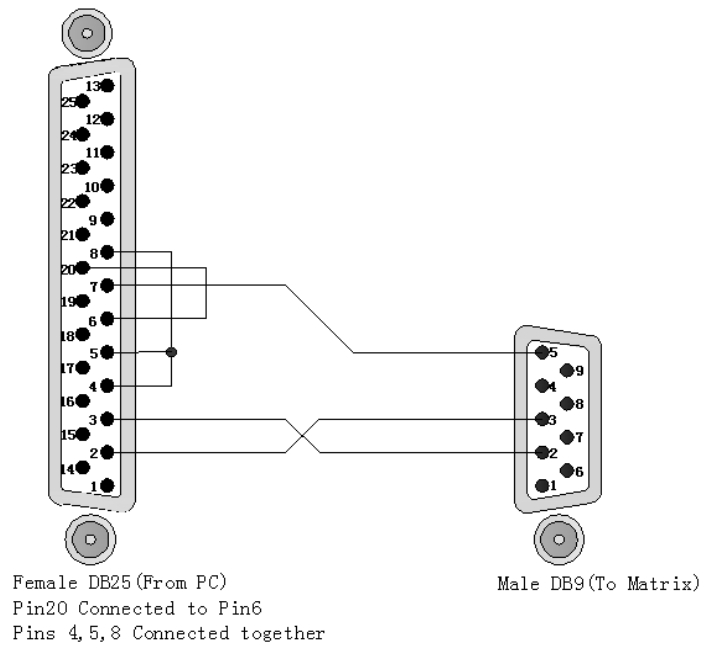

Figure 6-5 (b)

☞ The Matrix RS-232 port is defined as DCE.

6.0.3 IR2 Connection

Please connect the Extended IR Line to the IR2 port that is on the rear panel.

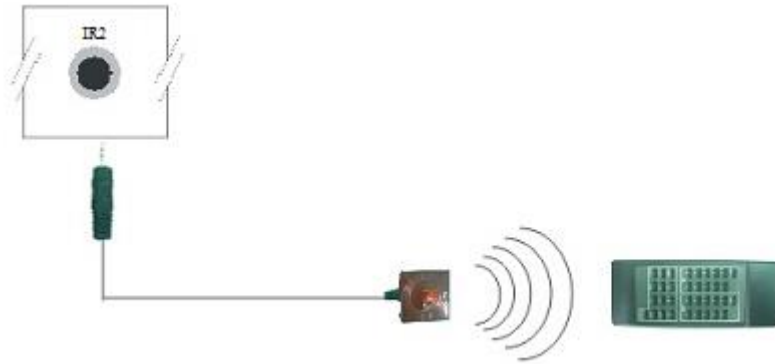

Figure 6-6 IR Connection

6.0.4 Power connection

Use the included power cord to connect from the power port on the rear panel of HDMI matrix host to the outlet.

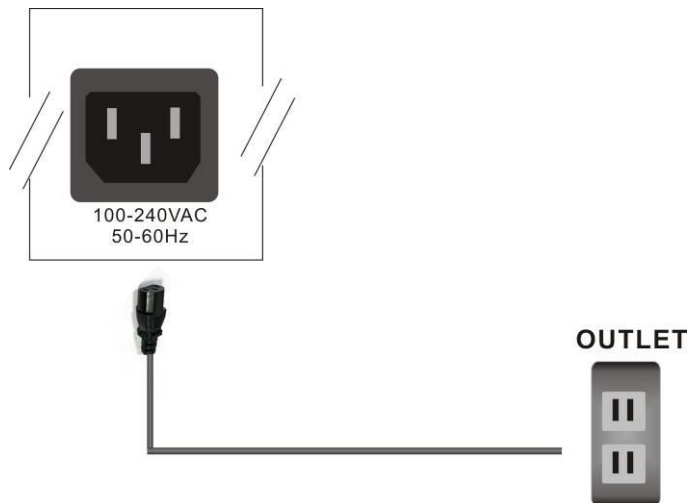

Figure 6-7 Power Connection

7.0 Matrix Application Software

7.0.1 Software Introduction

The 《AV Matrix》 Matrix control software applies to different input/output matrixes.

7.0.1.1 Software Description

The 《AV Matrix》 matrix testing software is an application tool developed for matrix testing and application. The software operation environment is as follows:

Window98/2000/7/NT/XP/Vista/ operatng systems

32M interal memory or above

10M hard disk space or above

CD-ROM

At least one serial communication port

7.0.1.2 Software Activation

First, you must power off both the HDMI matrix and the computer. Then, connect the matrix RS-232 port to the PC RS-232 port with the bundled communication cable. (Refer to the previous section “**HDMI Matrix and Control Computer Connection**”).

Power on the **HDMI** matrix and the computer:

Activate the **AV Matrix.exe** on the bundled CD-ROM in the control computer to enter the software configuration screen.

7.0.2 RS-232 Software Configuration

The software controls signal connection between the corresponding input port and output port as required. The RS-232 main configuration screen is as below:

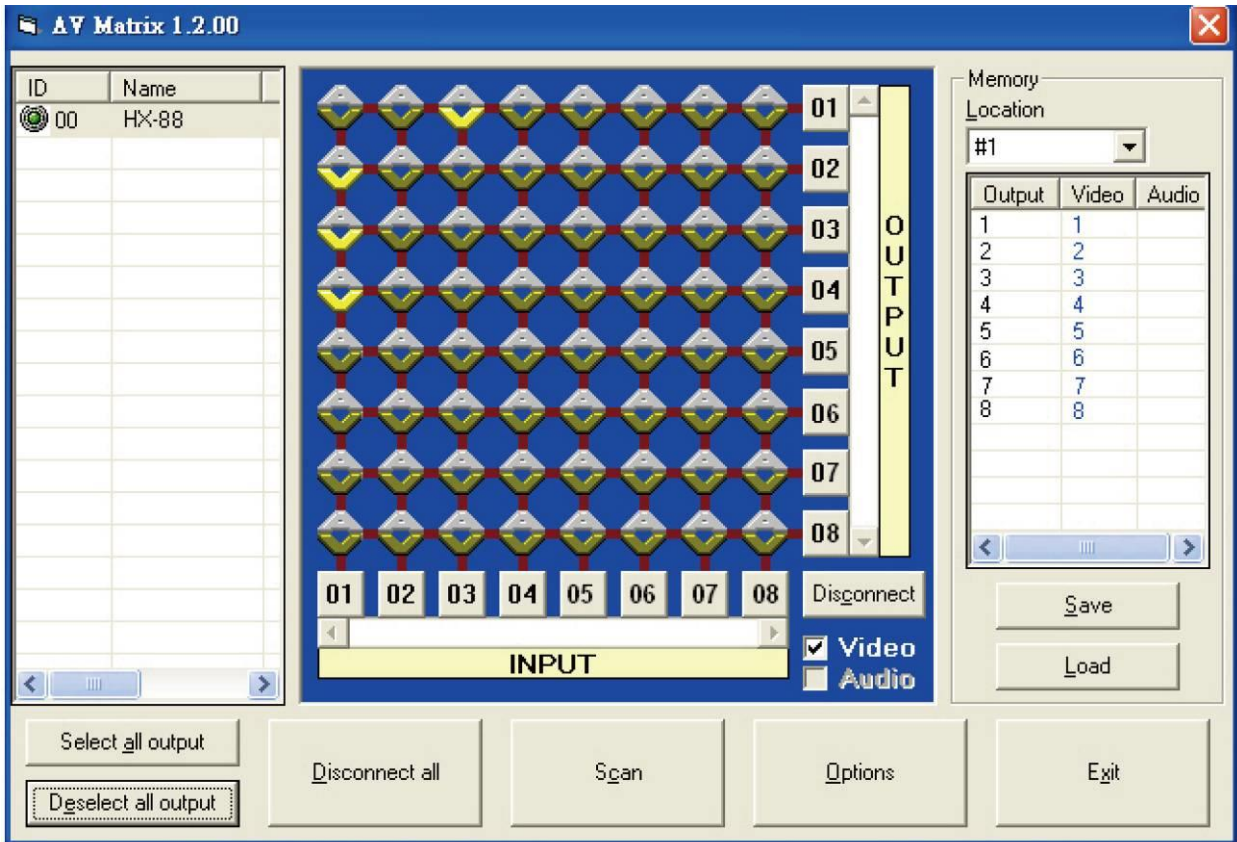

Figure 7-1 RS-232 Software Configuration Screen

☞ HX-88 is integrated Video/Audio switching equipment; please select the **Video** check box before you begin to operate the software.

Scroll on the left area of the main screen to view contents as shown below.



	A/V	I/O	Memory
88	Both	8 / 8	8

7.0.2.1 RS-232 Main Operation Interface

Refer to the main configuration screen as above, the marked blue area shows crossing matrix of output ports 01-08 and input ports 01-08. For basic operation, see described as below:

Examples for Selecting Matrix Switching Functions:

Example: Now there is an HX-88 matrix having all the input/output ports properly connected to the equipment. If you want to set channel 1 input to channel 2, 3 and 4 output; channel 3 inputs to channel 1 output. There are 2 ways to implement the switching. Please follow the directions and steps to finish the switching functions:

First way: Make sure you have selected “**Video**” check box (**Video**). Directly click on the corresponding icons on the matrix  to transform them into  to complete the switching operation.

Second way:

Step 1: Make sure you have selected “**Video**” check box (**Video**).

Step 2: First select the “**Output**” number keys 02, 03 and 04 to the right of the blue configuration area, and select the “**Input**” number key 01 to the bottom. Then, press consecutively the previously selected “**Output**” number keys 02, 03 and 04 (or you can press the “**Deselect all output**” key). This way, you have selected “**Input**” 01 and “**Output**” 02, 03 and 04 switching.

Step 3: First select the “**Output**” number key 01 to the right of the blue configuration area, and select the “**Input**” number key 03 to the bottom. Then, press the previously selected “**Output**” number key 01 (or you can press the “**Deselect all output**” key). This way, you have selected Input 03 and Output 01 switching.

Upon completion of the above 3 steps, you have actually completed the switching operation of having channel 1 input to channel 2, 3 and 4 output while at the same time successfully switched from channel 3 input to channel 1 output.

The main configuration screen also shows you some function buttons for easy operation:

Disconnect: To disable the connections. After you had configured the connection between input and output ports, you can click this button to disable the connections.

Select all output: Click this button to select all output ports including output 01~08.

Deselect all output: Click this button to cancel presently selected output ports. After you had configured a connected combination, please click this button first for next settings.

Disconnect all: To stop all the connections.

Scan: To search the host controlled by the RS-232 Software Configuration. When the host name located on the left of the main configuration screen is empty, you can click the

Scan to research and update the host **Name** and **ID**.

Options: Allows you to configure the **Port number** and **Baud rate**.

Exit: Click this button to exit the configuration screen.

Save: Click this button to save the connected combinations both output ports and input ports.

Load: Click this button to retrieve the previously saved settings.

For more information and operations, please refer to next chapters.

7.0.2.2 Disconnect Function Keys

Disable all the unused output ports.

A specific example of operation is described as below:

The present input and output relations are shown in Figure 7-2 below:

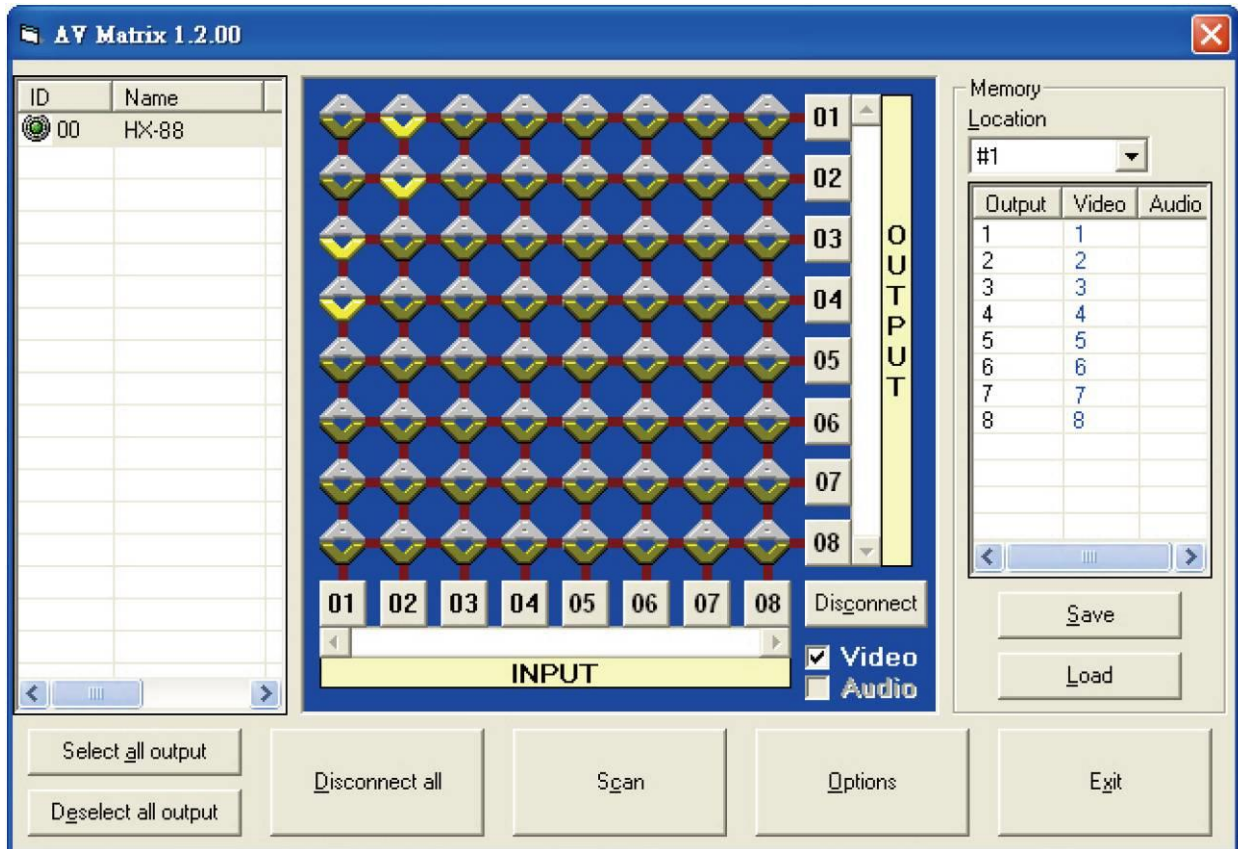

Figure 7-2

First you have to disable the output ports including port 03、02、and 01.

- Step 1:** First press down the output number keys 03, 02 and 01 to the right of the blue configuration area.
- Step 2:** Press the “Disconnect” key;
- Step 3:** Press the previously pressed output number keys 03, 02 and 01 (or press the “Deselect all output” key) to complete the operation.

The final results will be as shown in Figure 7-3 below:

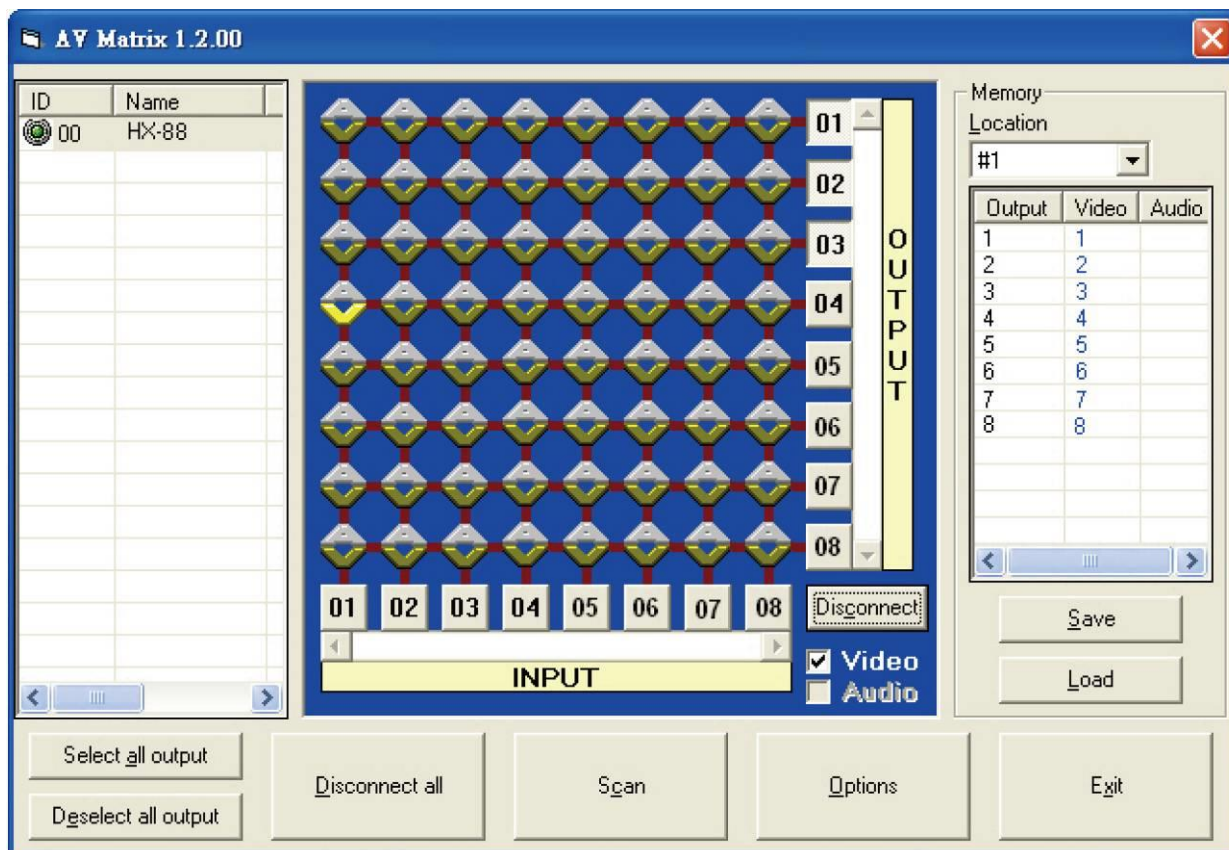



Figure 7-3

7.0.2.3 Select all output, DeSelect all output Switching Functions

(1) **Select all output Function Description:** You can use this function to select all output ports and rout them to one input port.

A specific example of operation is described below:

Example: Now, you have an HX-88 matrix with all input and output ports properly connected to the equipment. The needed input/output ports should be set to channel 1 input to all output-ports to output.

Make sure you have selected the “**Video**” check box (Video). Then, press the “**Select all output**” key and select the input number key 01. Click on the matrix icons along the 01 row  to transform them into  to complete the command operation.

(2) **DeSelect all output Function Description:** It is used to disable the **Select all output** function.

7.0.2.4 Disconnect all Command

Function Description: To disable all the switching functions. Press the “**Disconnect all**” key to disable all the connections of input and output ports.

7.0.2.5 RS-232 Memory Function

Function Description: To store and retrieve the settings.

Store Function Description: The **Store Function** saves all the present input/output switching relations to any Locations from #1 to #8 you desire.

A specific example of the Store Function is described below:

Store all the present input/output switching relations to Location #1. First, select Location #1, as shown in the figure below. Then click the **Save** key to save all the present input/output switching relations to Location #1.

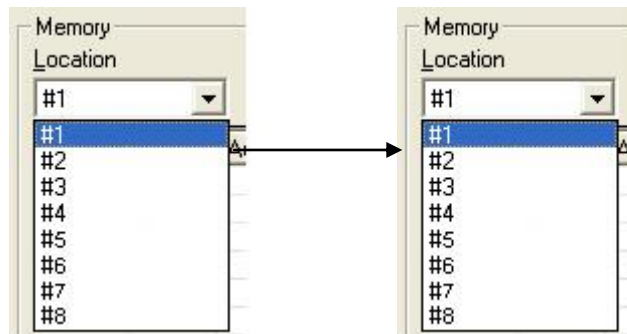

Figure 7-4

Retrieve Function Description: To retrieve the saved input/output switching relations.

A specific example of the Retrieve Function is described below:

To retrieve the input/output corresponding relations saved in Location #1. First, select Location #1 as shown in the figure below. Then click the **Load** key to retrieve all the Input / output corresponding relations stored in Location #1.

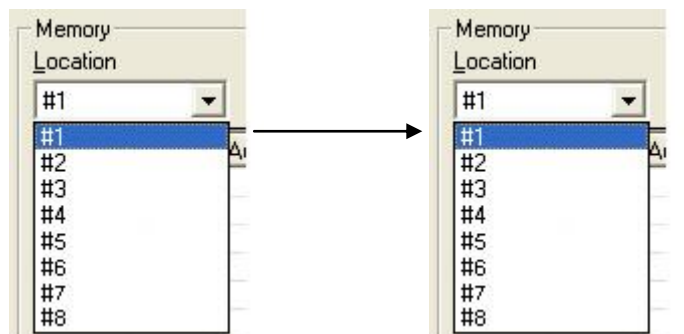

Figure 7-5

7.0.2.6 Options Function

Activation Function:

In the main configuration menu, select **Options** to pop up the **Options Window** as shown in Figure 7-6 (a)

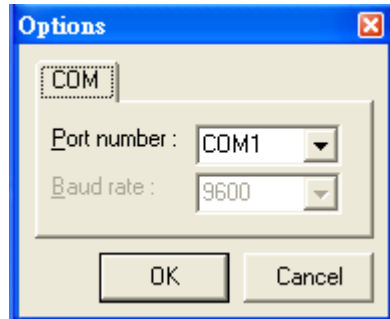

Figure 7-6 (a)

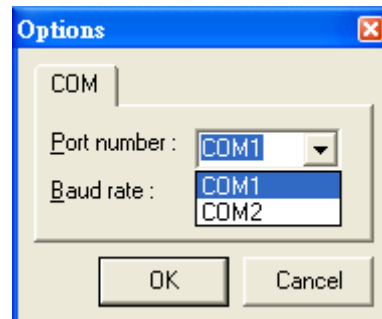

Figure 7-6 (b)

Function Description:

Linking Methods: In “Port number” select either COM1 port or COM2 port as shown in Figure 7-6(b); in “Baud rate” select 9600 for signal transmission as shown in Figure 7-6 (a)

7.0.2.7 Other Application

Displays the presently saved switching status as shown in Figure 6-7 below:

Output	Video	Audio
1	1	
2	2	
3	3	
4	4	
5	5	
6	6	
7	7	
8	8	

Figure 7-7

When input corresponding to Output is enabling, it shows the Output ports corresponding to the Input ports; when they are disable it will show red “**None**” in the relative field.

7.0.2.8 Communication Protocol/Control Command Code

Communication Protocol: Baud rate 9600bps, no odd or even calibration bit address, 8bit transmission address, 1bit stop address. Please refer to the “**Command list.pdf**” in the CD-ROM for more relative **Command Code** information.

7.0.3 LAN Web Configuration

Open the **Browser**, key in the default IP address: <http://192.168.0.3> to login the **AV MATRIX Control** configuration screen. Once the default IP address is changed, please use the changed IP to login.

The software controls signal connection between the corresponding input port and output port as required. The LAN main configuration screen is as below:

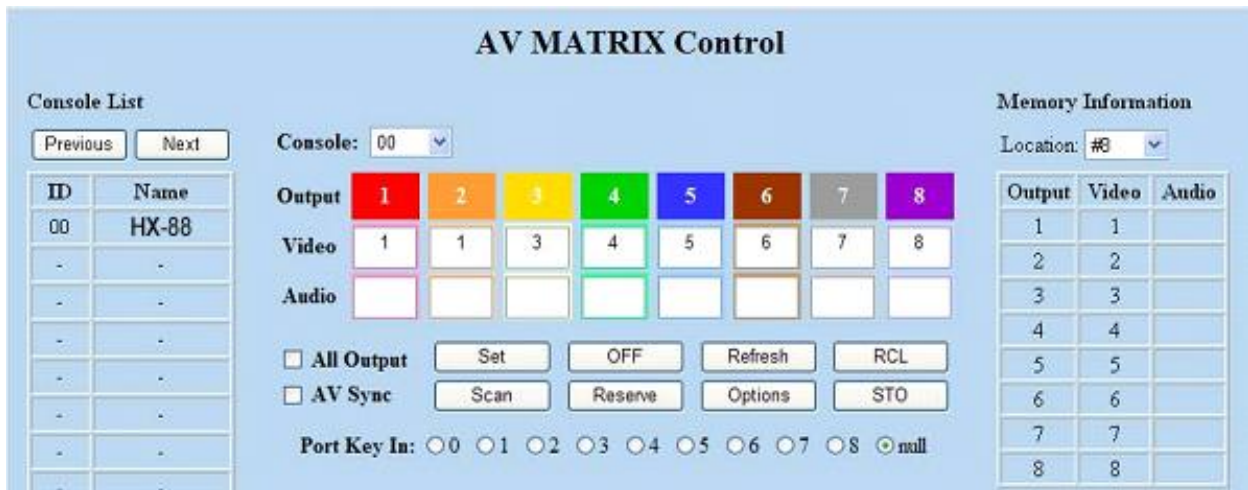

Figure 7-8 LAN Web Configuration Screen

☞ HDMI is integrated Video/Audio switching equipment; please only key in the Output Channel No. into the **Video** field, the **Audio** field value will be a default depends on the **Video** value automatically.

Scan: To search the host controlled by the LAN Web Configuration. When the **Console List** content is empty, you can click the **Scan** to research and update the Console List.

Options: Allows you to configure the **IP** address.

Set: Click this button to set the connected combinations both output and input ports.

Refresh: To refresh the values of the configuration screen. Any changed settings directly on the HX-88 equipment will not respond to the AV Matrix operating interface, you have to click the **Refresh** button to refresh the configuration screen so that it shows the changed values.

OFF: Disable the entire output channels.

STO: The “**Store Key**” saves all current input/output corresponding relations.

RCL: The “**Retriever Key**” retrieves the saved input/output corresponding relations.

☞ For more related information, please refer to **5.0.1. Front Panel**.

All Output: A Hot Key for you to set the same value to all output channel. Select the **All Output** check box, then key in example “**5**” value in the channel 1 output. Click anywhere on the screen, the all channel outputs will become “**5**” value.



Figure 7-9

Port Key In: A Hot key is for keying in the Values1~8 quickly.

Reserve and AV Sync: Not supported for this Model.

Previous and Next: Not supported for this Model

7.0.3.1 LAN Main Operation Interface

Refer to the main configuration screen as above, for the basic operation see described as below:

Example: HX-88 matrix having all the input/output ports properly connected to the equipment. If you want to set channel 1 input to channel 2, 3 and 4 output; channel 3 inputs to channel 1 output.

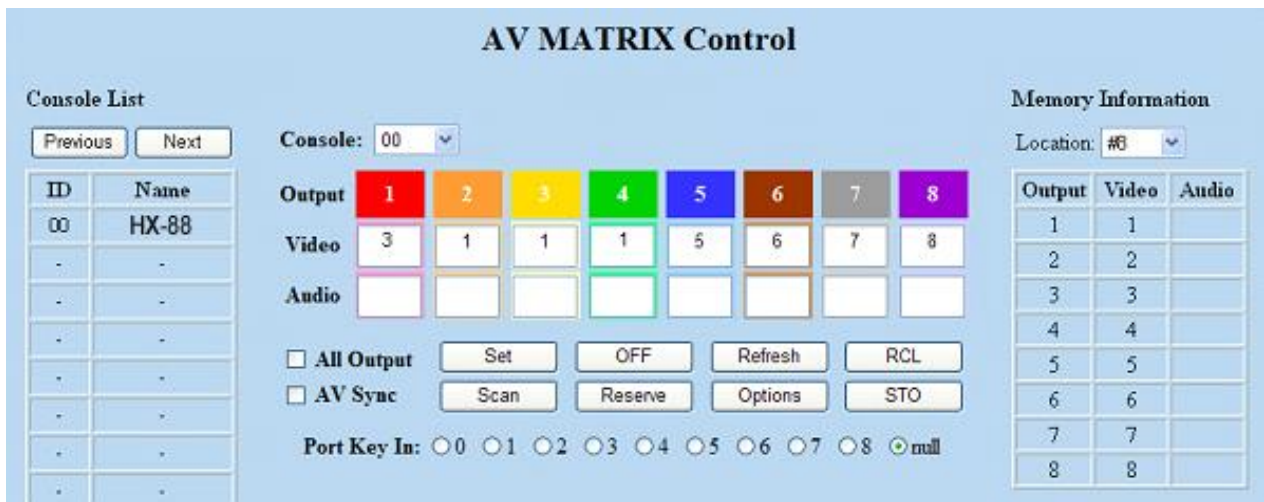

Figure 7-10

Step 1: For channel 2, 3, 4 Output, please keyin the value “1” in the **Video** fields.

Step 2: For channel 1 Output, please keyin the value “3” in the **Video** fields.

Step 3: Click “**Set**” button.

Upon completion of the above 3 steps, you have actually completed the switching operation of having channel 1 input to channel 2, 3 and 4 ouput while at the same time successfully switched from channel 3 input to channel 1 output.

7.0.3.2 LAN Memory Function

Function Description: To store and retrieve the settings.

Store Function Description (STO): The **Store Function** saves all the present input/output switching relations to any Locations from #1 to #8 you desire.

A specific example of the Store Function is described below:

Store the present input/output switching relations to Location #2. First, select Location #2, as shown in the figure below. Then click the **STO** button to save the present input/output switching relations to Location #2.

Retrieve Function Description (RCL): To retrieve the saved input/output switching relations.

A specific example of the Retrieve Function is described below:

To retrieve the input/output corresponding relations saved in Location #1. Select the Location #1 as shown in the figure below. The input/output corresponding relations stored in Location #1 will be shown directly.



Figure 7-11

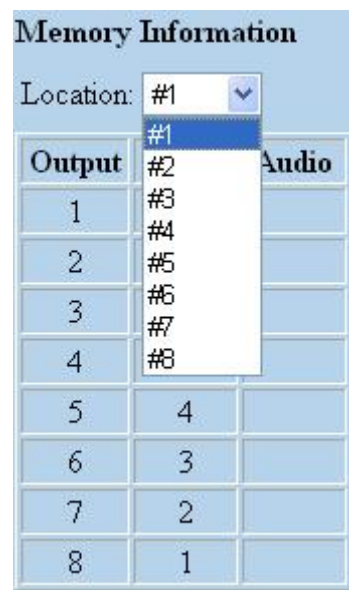

Figure 7-12

7.0.3.3 LAN IP Function

Activation Function:

In the main configuration menu, select **Options** button to prop up the **Windows Internet Explorer** dialog box, click “**OK**” to show the IP configuration screen as shown in Figure 7-11

Network Settings	
	<input type="checkbox"/> Enable DHCP
Static IP Address	192.168.0.3
Static Subnet Mask	255.255.255.0
Static Default Gateway	192.168.0.1
Static DNS Server	192.168.0.1
Physical Address	e4-46-bd-03-02-04
	<input type="button" value="Apply"/> <input type="button" value="Default"/> <input type="button" value="Reboot"/>

Figure 7-13

In the **Network Settings** configuration, you can set the IP information by yourself (Fix IP) or click the **Enable DHCP** check box to get the IP from the DHCP (Float IP).

☞ Click the **Default** button to restore to default IP address. After changing the IP, you have to restart (power off then power on) the Host to make the changed values take effect.

☞ You can also use the blue **Dip Switch** on the rear panel of the Host to reset the IP.

7.0.3.4 Other Application

The software utility will show you at least 32 unit host ID and Name. You can click the **Console** down list to select which Host that you want to configure output /input values as figure 7-14. The entire connected Host name will be shown on the **Console List** as figure 7-15. For this model, the software utility only shows an ID:00 for the Name: HX-88 presently.

☞ When the **Console List** is empty, please pay attention to the location of switch 1 on the rear panel of Host is correct. Then, click **Scan** to research the configured Host. For HX-88 model, only have to make the **Console** down list value to “00”.

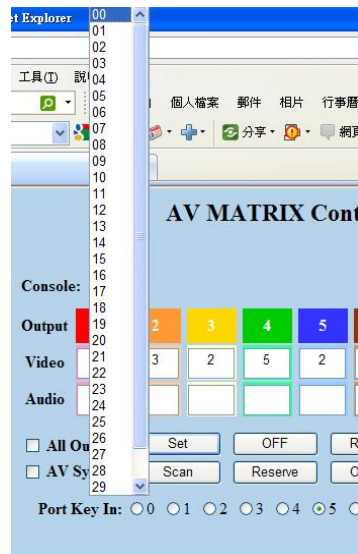

Figure 7-14

Console List	
Previous Next	
ID	Name
00	HX-88
-	-
-	-
-	-
-	-
-	-
-	-
-	-
-	-

Figure 7-15

8.0 Operation Examples

Example 1: Switch the NO.1 input signal to the NO.2 output channel.

Key	LCD Display	Operation
	<p>HDMI MATRIX</p> <p>OUT 1 2 3 4 5 6 7 8 EDID</p> <p>IN 0 0 0 0 0 0 0 0 FIX</p>	1. Press the NO.2 key of the output channel, then the input channels will begin to flicker.
	<p>HDMI MATRIX</p> <p>OUT 1 2 3 4 5 6 7 8 EDID</p> <p>IN 0 1 0 0 0 0 0 0 FIX</p>	2. Press the NO.1 key of the Input channel.



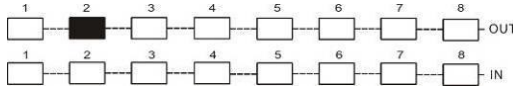
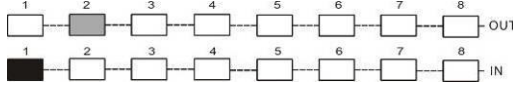
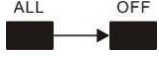

Example 2: Switch the NO.1 and NO.2 input signals to each NO.1 and NO.2 output channels.

Key	LCD Display	Operation
	<p>HDMI MATRIX</p> <p>OUT 1 2 3 4 5 6 7 8 EDID</p> <p>IN 0 0 0 0 0 0 0 0 FIX</p>	1. Press the NO.1 key of the output channel, then the input channels will begin to flicker.
	<p>HDMI MATRIX</p> <p>OUT 1 2 3 4 5 6 7 8 EDID</p> <p>IN 1 0 0 0 0 0 0 0 FIX</p>	2. Press the NO.1 key of the Input channel.
	<p>HDMI MATRIX</p> <p>OUT 1 2 3 4 5 6 7 8 EDID</p> <p>IN 1 0 0 0 0 0 0 0 FIX</p>	3. Press the NO.2 key of the output channel, then the input channels will begin to flicker.
	<p>HDMI MATRIX</p> <p>OUT 1 2 3 4 5 6 7 8 EDID</p> <p>IN 1 2 0 0 0 0 0 0 FIX</p>	4. Press the NO.2 key of the Input channel.

Example 3: Delete “All” settings.

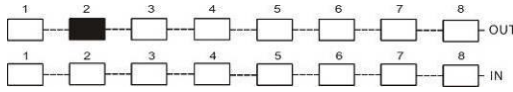
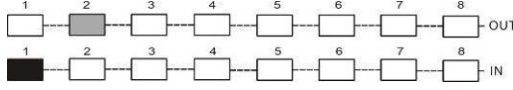
Key	LCD Display	Operation																				
 <p>The diagram shows an 8x8 matrix switch. The top row is labeled 'OUT' and the bottom row is labeled 'IN'. Both rows have columns numbered 1 through 8. The key at the intersection of row 2 and column 2 is highlighted in black.</p>	<p style="text-align: center;">HDMI MATRIX</p> <table border="1" style="margin-left: auto; margin-right: auto;"> <tr> <td>OUT</td> <td>1</td><td>2</td><td>3</td><td>4</td><td>5</td><td>6</td><td>7</td><td>8</td> <td>EDID</td> </tr> <tr> <td>IN</td> <td>0</td><td>0</td><td>0</td><td>0</td><td>0</td><td>0</td><td>0</td><td>0</td> <td>FIX</td> </tr> </table>	OUT	1	2	3	4	5	6	7	8	EDID	IN	0	0	0	0	0	0	0	0	FIX	<p>1. Press the NO.2 key of the output channel, then the input channels will begin to flicker.</p>
OUT	1	2	3	4	5	6	7	8	EDID													
IN	0	0	0	0	0	0	0	0	FIX													
 <p>The diagram shows an 8x8 matrix switch. The top row is labeled 'OUT' and the bottom row is labeled 'IN'. Both rows have columns numbered 1 through 8. The key at the intersection of row 1 and column 1 is highlighted in black.</p>	<p style="text-align: center;">HDMI MATRIX</p> <table border="1" style="margin-left: auto; margin-right: auto;"> <tr> <td>OUT</td> <td>1</td><td>2</td><td>3</td><td>4</td><td>5</td><td>6</td><td>7</td><td>8</td> <td>EDID</td> </tr> <tr> <td>IN</td> <td>0</td><td>1</td><td>0</td><td>0</td><td>0</td><td>0</td><td>0</td><td>0</td> <td>FIX</td> </tr> </table>	OUT	1	2	3	4	5	6	7	8	EDID	IN	0	1	0	0	0	0	0	0	FIX	<p>2. Press the NO.1 key of the Input channel.</p>
OUT	1	2	3	4	5	6	7	8	EDID													
IN	0	1	0	0	0	0	0	0	FIX													
 <p>The diagram shows two keys labeled 'ALL' and 'OFF'. An arrow points from the 'ALL' key to the 'OFF' key, indicating the sequence of operations.</p>	<p style="text-align: center;">HDMI MATRIX</p> <table border="1" style="margin-left: auto; margin-right: auto;"> <tr> <td>OUT</td> <td>1</td><td>2</td><td>3</td><td>4</td><td>5</td><td>6</td><td>7</td><td>8</td> <td>EDID</td> </tr> <tr> <td>IN</td> <td>0</td><td>0</td><td>0</td><td>0</td><td>0</td><td>0</td><td>0</td><td>0</td> <td>FIX</td> </tr> </table>	OUT	1	2	3	4	5	6	7	8	EDID	IN	0	0	0	0	0	0	0	0	FIX	<p>3. Press the ALL key on the front panel, and then press the OFF key to cancel all the settings.</p>
OUT	1	2	3	4	5	6	7	8	EDID													
IN	0	0	0	0	0	0	0	0	FIX													

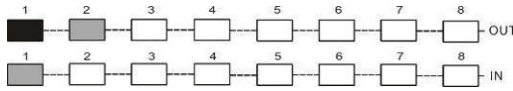
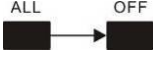
Example 4: “STO” and “RCL” functions.

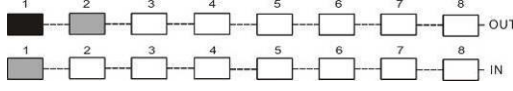
Key	LCD Display	Operation
 <p>A diagram of an 8x8 matrix switch. The top row is labeled 'OUT' and the bottom row is labeled 'IN'. Both rows have columns numbered 1 to 8. In this diagram, the key at the intersection of row 1 and column 2 is highlighted in black.</p>	<p>HDMI MATRIX</p> <p>OUT 1 2 3 4 5 6 7 8 EDID</p> <p>IN 0 0 0 0 0 0 0 0 FIX</p>	<p>1. Press the NO.2 key of the output channel, then the input channels will begin to flicker.</p>
 <p>A diagram of an 8x8 matrix switch. The top row is labeled 'OUT' and the bottom row is labeled 'IN'. Both rows have columns numbered 1 to 8. In this diagram, the key at the intersection of row 2 and column 1 is highlighted in black.</p>	<p>HDMI MATRIX</p> <p>OUT 1 2 3 4 5 6 7 8 EDID</p> <p>IN 0 1 0 0 0 0 0 0 FIX</p>	<p>2. Press the NO.1 key of the Input channel.</p>
<p>STO</p> 	<p>HDMI MATRIX</p> <p>OUT Store Memory: EDID</p> <p>IN 1 2 3 4 5 6 7 8 FIX</p>	<p>3. Press the STO key on the front panel. The Store Memory begins to flicker about 8 seconds.</p>
 <p>A diagram of an 8x8 matrix switch. The top row is labeled 'OUT' and the bottom row is labeled 'IN'. Both rows have columns numbered 1 to 8. In this diagram, the keys at (row 1, column 1) and (row 2, column 2) are highlighted in black.</p>	<p>HDMI MATRIX</p> <p>OUT Store Memory: EDID</p> <p>IN Save to 1 FIX</p>	<p>4. Press the NO.1 key of the output channel to save the setting in the NO.1 channel.</p>
<p>ALL → OFF</p> 	<p>HDMI MATRIX</p> <p>OUT 1 2 3 4 5 6 7 8 EDID</p> <p>IN 0 0 0 0 0 0 0 0 FIX</p>	<p>5. Press the ALL key on the front panel, and then press the OFF key to cancel the setting.</p>
<p>RCL</p> 	<p>HDMI MATRIX</p> <p>OUT Recall Memory: EDID</p> <p>IN 1 2 3 4 5 6 7 8 FIX</p>	<p>6. Press the RCL key on the front panel, The Recall Memory begins to flicker about 8 seconds.</p>
 <p>A diagram of an 8x8 matrix switch. The top row is labeled 'OUT' and the bottom row is labeled 'IN'. Both rows have columns numbered 1 to 8. In this diagram, the keys at (row 1, column 1) and (row 2, column 2) are highlighted in black.</p>	<p>HDMI MATRIX</p> <p>OUT Recall Memory: EDID</p> <p>IN Load from 1 FIX</p>	<p>7. Press the NO.1 key of the output channel to Load the previously saving.</p>

9.0 Troubleshooting

1. What to do if the HDMI matrix front panel keys switching not responsive?

Answer: The HDMI matrix front panel keys employ scanning testing and require longer response time. Press the keys for 2 seconds and then release. This way, key switching will be responsive in operation.

2. What to do if matrix does not display or color display is abnormal after hot plug?

Answer: Switching of the matrix system goes through the IC chips. If the voltage difference between the input signal equipment and the matrix equipment is too large, hot plug could easily cause damage to the IC chips. Please turn off power to the system before plugging or unplugging.

3. What to do if loss of color reproduction happens or no video signal output?

Answer: Please check if connectors at both ends of the HDMI signal cable are correctly connected.

4. What to do if the serial port (usually refer to the computer serial port) fails to control the HDMI matrix?

Answer: Check that the communication port set by the control software is correctly connected to the corresponding serial port of the equipment. Also, check if the computer communication port is in good order.

5. What to do if the corresponding graphics fail to output during HDMI matrix switching?

Answer:

- (1) Check if there is signal on the input end. If there is no input signal, it could be that the input connection cable is broken. You are advised to replace the connection cable.
- (2) Check if the output port number is the same as the controlled port number.
- (3) If none of the above circumstances happen, it could be internal failure of the product itself. Please contact factory technical engineer.

6. What to do if you sense the power leakage during plugging or unplugging of the input/output ports?

Answer: It could be that the equipment power is not properly grounded. You must properly ground your equipment; otherwise product life can easily be shortened.

7. What to do if the LCD displays normally and the communication port has return code but no image output?

Answer:

- (1) It could be that the output/input connectors got loosen. Simply replace the connectors.
- (2) It could be the connection cable short-circuited. Simply replace the cable.
- (3) It could be the connection cable is broken. Simply replace the cable.

8. What to do if the HDMI matrix panel keys and communication ports are out of order?

Answer: Check if the equipment power input is in good contact and the computer communication ports are in good order. Please contact factory technical engineer.

9. What to do if operation and function failure occurred?

Answer: Check if the equipment and the matrix switch are properly connected. If the problem persists, please contact factory technical engineer.

Appendix A Command List

AV Matrix Protocol v2.0

A-1 Host Request Table

A-2 Device Acknowledge Type

A-1 Host Request Table

This RS-232 / RS-485 communication protocol uses five bytes of information as defined below.

Host	Target + Request + Index + Value + CRC							
Name	Bit 7	Bit 6	Bit 5	Bit 4	Bit 3	Bit 2	Bit 1	Bit 0
Target	BT	0	1	Device ID (0 - 31)				
Request	VAR	0	Request (0 - 63)					
Index	Index							
Value	Value							
CRC	CRC							

BT : 0: Instruction for device ID only.

(Broadcast) 1: Instruction for all devices. (Device ID must be written 0)

※Devices will not response, when receiving the broadcast request.

0 (Reserve) : Reserve, Always 0.

1 (Identifier) : Identifier, Always 1.

Device ID : Device id ranges from 0 to 31.

VAR : 0: Normal length command. (Recommended)

(variable) 1: Variable length command. (Only support the command is Ack Type A)

If the VAR (variable) is 1, please refer to the table below.

CRC : Send CRC code to follow the last byte.

Variable	Target + Request + LB + Index1 + Value1 + Index2 + Value2 + + CRC							
Name	Bit 7	Bit 6	Bit 5	Bit 4	Bit 3	Bit 2	Bit 1	Bit 0
Target	BT	0	1	Device ID (0 - 31)				
Request	VAR	0	Request (0 - 63)					
LB	Length							
Index 1	Index 1							
Value 1	Value 1							
...							
Index n	Index n							
Value n	Value n							
CRC	CRC							

LB (Length) : LB value is equal to the total (Index + Value). Not include the CRC byte.
The default maximum length is 128. (If the extended information does not exist.)

※The default baud rate is 9600, with no parity, 8 data bits and 1 stop bit.

Host Request Table

This RS-332 / RS-485 communication protocol uses five bytes of information as defined below.

Communication Protocol v2.00					2011.06.17			
Request Description	Byte 1	Byte 2	Byte 3	Byte 4	Byte 5	Features	Parameter Description	Value Description
Switch Tools	Target	Request	Index	Value	CRC	Ack Type	Index Description	Value Description
Dummy call	ID	0x00	-	-	CRC	A	Index - Don't care	Value - Don't care
Switch Video	ID	0x01	Output	Input	CRC	A	Output - The output that will be switched	Input - The input that will be connected
Switch Audio	ID	0x02	Output	Input	CRC	A	0 : All outputs	0 : Disconnect
Store Video Status	ID	0x03	Video	Memory	CRC	A	Video - 0 : All Status	
Store Audio Status	ID	0x04	Audio	Memory	CRC	A	1 : Switch only	Memory - Select Memory#, Not to 0
Recall Video Status	ID	0x05	Video	Memory	CRC	A	Audio - 0 : All Status	
Recall Audio Status	ID	0x06	Audio	Memory	CRC	A	1 : Switch only	
Request Status of Video Output	ID	0x07	Output	Memory	CRC	B	2 : Audio Setting only	
Request Status of Audio Output	ID	0x08	Output	Memory	CRC	B	Output - The output that will be requested	Memory - Request from the Memory#
							0 : All outputs	0 : Current Status
Plug Detect								
Request Video Input Plug Status	ID	0x09	Input	0	CRC	B	Input - The input that will be requested	Value - Write as 0 always.
Request Audio Input Plug Status	ID	0x0A	Input	0	CRC	B	0 : All inputs	
Request Video Output Plug Status	ID	0x0B	Output	0	CRC	B	Output - The output that will be requested	Value - Write as 0 always.
Request Audio Output Plug Status	ID	0x0C	Output	0	CRC	B	0 : All outputs	
Audio Control								
Control Audio Mute	ID	0x10	Output	Status	CRC	A		
Request Audio Mute Status	ID	0x11	Output	Memory	CRC	B	Status - Mute Status	0x00 : Unmute
Control Audio Volume	ID	0x12	Output	Level	CRC	A	0x01 : Mute	
Request Audio Volume Level	ID	0x13	Output	Memory	CRC	B		
Control Audio Bass	ID	0x14	Output	Level	CRC	A	Output - The output that will be controlled	Memory - Request from the Memory#
Request Audio Bass Level	ID	0x15	Output	Memory	CRC	B	0 : All outputs	0 : Current Status
Control Audio Treble	ID	0x16	Output	Level	CRC	A		Level - Level Range (0 - 100)
Request Audio Treble Level	ID	0x17	Output	Memory	CRC	B		0x81 : Increase a step
Control Audio Subwoofer	ID	0x18	Output	Level	CRC	A		0x82 : Decrease a step
Request Audio Subwoofer Level	ID	0x19	Output	Memory	CRC	B		

Video Control																					
Select EDID Type	ID	0x20	Input	Type	CRC		A	Input - The input that will be selected 0 : All inputs		Type - EDID Type, 0x00 : Fix (default) 0x01 : Output 1											
Request EDID Type	ID	0x21	Input	0	CRC		B														
Device Information																					
Request Firmware Version	ID	0x31	0	0	CRC		C	Index - Write as 0 always.		Value - Write as 0 always.											
Request Device Information	ID	0x3F	0	0	CRC		D	Index - 0: Information and Device Name 1: Extend Information		Value - Write as 0 always.											
		0x3F	1	0	CRC		E														

※The default baud rate is 9600, with no parity, 8 data bits and 1 stop bit.

Cyclic Redundancy Check Table

CRC	0	1	2	3	4	5	6	7	8	9	A	B	C	D	E	F
0x00	0x00	0x5E	0xBC	0xE2	0x61	0x3F	0xDD	0x83	0xC2	0x9C	0x7E	0x20	0xA3	0xFD	0x1F	0x41
0x10	0x9D	0xC3	0x21	0x7F	0xFC	0xA2	0x40	0x1E	0x5F	0x01	0xE3	0xBD	0x3E	0x60	0x82	0xDC
0x20	0x23	0x7D	0x9F	0xC1	0x42	0x1C	0xFE	0xA0	0xE1	0xBF	0x5D	0x03	0x80	0xDE	0x3C	0x62
0x30	0xBE	0xF0	0x02	0x5C	0xDF	0x81	0x63	0x3D	0x7C	0x22	0xC0	0x9E	0x1D	0x43	0xA1	0xFF
0x40	0x46	0x18	0xFA	0xA4	0x27	0x79	0x9B	0xC5	0x84	0xDA	0x38	0x66	0xE5	0xBB	0x59	0x07
0x50	0xDB	0x85	0x67	0x39	0xBA	0xF4	0x06	0x58	0x19	0x47	0xA5	0xFB	0x78	0x26	0xC4	0x9A
0x60	0x65	0x3B	0xD9	0x87	0x04	0x5A	0xB8	0xE6	0xA7	0xF9	0x1B	0x45	0xC6	0x98	0x7A	0x24
0x70	0xF8	0xA6	0x44	0x1A	0x99	0xC7	0x25	0x7B	0x3A	0x64	0x86	0xD8	0x5B	0x05	0xE7	0xB9
0x80	0x8C	0xD2	0x30	0x6E	0xED	0xB3	0x51	0x0F	0x4E	0x10	0xF2	0xAC	0x2F	0x71	0x93	0xCD
0x90	0x11	0x4F	0xAD	0xF3	0x70	0x2E	0xCC	0x92	0xD3	0x8D	0x6F	0x31	0xB2	0xEC	0x0E	0x50
0xA0	0xAF	0xF1	0x13	0x4D	0xCE	0x90	0x72	0x2C	0x6D	0x33	0xD1	0x8F	0xC0	0x52	0xB0	0xEE
0xB0	0x32	0x6C	0x8E	0xD0	0x53	0xD	0xEF	0xB1	0xF0	0xA	0x4C	0x12	0x91	0xCF	0x2D	0x73
0xC0	0xCA	0x94	0x76	0x28	0xAB	0xF5	0x17	0x49	0x08	0x56	0xB4	0xEA	0x69	0x37	0xD5	0x8B
0xD0	0x57	0x09	0xFB	0xB5	0x36	0x68	0x8A	0xD4	0x95	0xCB	0x29	0x77	0xF4	0xAA	0x48	0x16
0xE0	0xE9	0xB7	0x55	0x0B	0x88	0xD6	0x34	0x6A	0x2B	0x75	0x97	0xC9	0x4A	0x14	0xF6	0xA8
0xF0	0x74	0x2A	0xC8	0x96	0x15	0x4B	0xA9	0xF7	0xB6	0xF8	0x0A	0x54	0xD7	0x89	0x6B	0x35

A-2 Device Acknowledge Type

Device ACK Type

The device returns an acknowledge packet as defined below.

Ack Type	Byte 1	Byte 2	Byte 3	Byte 4	Byte 5	Byte 6	Last Byte
Type A	ACK							CRC
Type B	ACK	LB	Index1	Value1	Index2	Value2	CRC
Type C	ACK	LB	Data1	Data2				CRC
Type D	ACK	LB	INF	OP	IP	Mn1	CRC
Type E	ACK	LB	EXTI	VIDI	AUDI	PLUG	CRC

※The device is always send the CRC code to follow the last byte.

Type A	ACK + CRC (Total 2 Bytes)							
Name	Bit 7	Bit 6	Bit 5	Bit 4	Bit 3	Bit 2	Bit 1	Bit 0
ACK	ACC	0	0	Device ID (0 - 31)				
CRC	CRC							

ACC (Accept) : 1: Device accepts this request. (acknowledge)

0: Device rejects this request. (NAK; negative acknowledge)

※The device sends the Nak packet is always 2 bytes. (NAK + CRC)

0 (Reserve) : Reserve, Always 0.

CRC : Send CRC code to follow the last byte.

Type B	ACK + LB + Index1 + Value1 + Index2 + Value2 + + CRC							
Name	Bit 7	Bit 6	Bit 5	Bit 4	Bit 3	Bit 2	Bit 1	Bit 0
ACK	ACC	0	0	Device ID (0 - 31)				
LB	Length							
Index N	Index							
Value N	Value							
...							
CRC	CRC							

LB (Length) : LB value is equal to the total (Index + Value). Not include the CRC byte.

Index : Often means that the input or output port number.

Value : Response the status refers to the table.

Request Description	Request	Index	Value
Request Status of Video Output	0x07	Output	Input
Request Status of Audio Output	0x08		
Request Video Input Plug Status	0x09	Input	1: Plug 0: Unplug
Request Audio Input Plug Status	0x0A	Output	
Request Video Output Plug Status	0x0B		
Request Audio Output Plug Status	0x0C	Output	0: Unmute, 1: Mute
Request Audio Mute Status	0x11		
Request Audio Volume Level	0x13		Level Range (0 - 100)
Request Audio Bass Level	0x15		
Request Audio Treble Level	0x17		
Request Audio Subwoofer Level	0x19		
Request EDID Type	0x21	Input	0: Default, 1: Output 1

Type C	ACK + LB + Data1 + Data2 + CRC (Total 5 Bytes)							
Name	Bit 7	Bit 6	Bit 5	Bit 4	Bit 3	Bit 2	Bit 1	Bit 0
ACK	ACC	0	0	Device ID (0 - 31)				
LB	Length							
Data1	Data 1							
Data2	Data 2							
CRC	CRC							

LB (Length) : LB value is always 2 (Data1 + Data2). Not include the CRC byte.

Data : Response the data refer to the table

Request Description	Request	Data1		Data2
Request Firmware Version	0x31	VerA	VerB	VerC

F/W Version : Contains the VerA, VerB and VerC (ex: VerA.VerB.VerC)

Data1 : Bit 7~4 : VerA (Range 0 - 9)

Bit 3~0 : VerB (Range 0 - 9)

Data2 : Bit 7~0 : VerC (Range 0 - 99)

If the Data1 is 0x10 and Data2 is 0x07

=> VerA = 1, VerB = 0 and VerC = 7, Firmware version is v1.0.07

If the Data1 = 0x23 and Data2 = 0x45

=> VerA = 2, VerB = 3 and VerC = 69, Firmware version is v2.3.6

Type D	ACK + LB + INF + OP + IP + Mn1 + Mn2 + Mn3 + + CRC							
Name	Bit 7	Bit 6	Bit 5	Bit 4	Bit 3	Bit 2	Bit 1	Bit 0
ACK	ACC	0	0	Device ID (0 - 31)				
LB	Length							
INFO	Audio	Video	Extend	0	Total Memory Location (0 - 15)			
OP	Total Output Port							
IP	Total Input Port							
Mn1	Device Name (ASCII code)							
...							
Mnx	Device Name (ASCII code)							
CRC	CRC							

LB (Length) : LB value is the total length, not include the ACK, LB and CRC byte.

INFO : Device information

Bit 7 : 1 - Support Audio switch tools request. (Request 0x02, 0x04, 0x06, 0x08)
0 - Not support Audio switch tools request.

Bit 6 : 1 - Support Video switch tools request. (Request 0x01, 0x03, 0x05, 0x07)
0 - Not support Video switch tools request.

Bit 5 : 1 - Extended information exists. (Request 0x3F[0x01])
0 - Extended information does not exist.

Bit 4 : Reserve, always 0.

Bit 3~0 : Total Memory location.

※Request[Index], if 0x3F[0x01] => Request = 0x3F and Index = 0x01

OP : Total Output Port.

IP : Total Input Port.

Mn1~Mnx : Device Name (ASCII code). (The maximum length is 16)

Type E	ACK + LB + EXTI + VIDI + AUDI + PLUG + + CRC							
Name	Bit 7	Bit 6	Bit 5	Bit 4	Bit 3	Bit 2	Bit 1	Bit 0
ACK	ACC	0	0	Device ID (0 - 31)				
LB	Length							
EXTI	LBMAX	0	0	0	0	0	0	FWVER
VIDI	EDID	0	0	0	0	0	0	0
AUDI	0	0	0	0	Subwoofer	Treble	Bass	Volume
PLUG	0	0	0	0	AOPD	VOPD	AIPD	VIPD
...							
CRC	CRC							

- EXTI** : Device extended information
- INFO** : Device information
- Bit 7 : **LBMAX** - defines the maximum LB value of the variable length command.
- 0 - The maximum LB is 128 Bytes. (default)
 - 1 - The maximum LB is 254 Bytes. (255 is reserved)
- The LB value of the Ack packet is not limited by LBMAX.
- If the extended information does not exist, the default maximum length is 128.
- Bit 6~1 : Reserve, always 0.
- Bit 0 : 1 - Support Firmware version request. (Request 0x31)
- 0 - Not support Firmware version request.
- VIDI** : Video Extend Information
- Bit 7 : 1 - Support EDID type select request. (Request 0x20 - 0x21)
- 0 - Not support EDID type select request.
- Bit 6~0 : Reserve, always 0.
- AUDI** : Audio Extend Information.
- Bit 0 : 1 - Support Volume and Mute control. (Request 0x10 - 0x13)
- 0 - Not support Volume control.
- Bit 1 : 1 - Support Bass control. (Request 0x14 - 0x15)
- 0 - Not support Bass control.
- Bit 2 : 1 - Support Treble control. (Request 0x16 - 0x17)
- 0 - Not support Treble control.
- Bit 3 : 1 - Support Subwoofer control. (Request 0x18 - 0x19)
- 0 - Not support Subwoofer control.
- Bit 7~4 : Reserve, always 0.
- ※If the AUDI is not equal to 0, the device support Request 0x04[0x02] and 0x06[0x02].
- PLUG** : Plug Detect Support Information.
- Bit 0 : 1 - Support Video input plug detection. (Request 0x09)
- 0 - Not support Video input plug detection.
- Bit 1 : 1 - Support Audio input plug detection. (Request 0x0A)
- 0 - Not support Audio input plug detection.
- Bit 2 : 1 - Support Video output plug detection. (Request 0x0B)
- 0 - Not support Video output plug detection.
- Bit 3 : 1 - Support Audio output plug detection. (Request 0x0C)
- 0 - Not support Audio output plug detection.
- Bit 7~4 : Reserve, always 0.

WARRANTY

LIMITED WARRANTY – with the exceptions noted in the next paragraph, ZIGEN warrants the original purchaser that the equipment it manufactures or sells will be free from defects in materials and workmanship for a period of one year from the date of purchase. The proof of sale is required in order to claim warranty. Should this product, in ZIGEN's opinion, prove defective within this warranty period, ZIGEN, at its option, will repair or replace this product without charge. Customers outside of US are responsible for shipping charges to and from ZIGEN. Any defective parts replaced become the property of ZIGEN. This warranty does not apply to those products which have been damaged due to accident, unauthorized alterations, improper repair, modifications, inadequate maintenance and care, or use in any manner for which the product was not originally intended for. Items integrated into ZIGEN products that are made by other manufacturers, notably computer hard drives and liquid crystal display panels, are limited to the term of the warranty offered by the respective manufacturers. Such specific warranties are available upon request to ZIGEN.

ZIGEN makes no other representation of warranty as to fitness for the purpose or merchantability or otherwise in respect of any of the products sold. The liability of ZIGEN with respect to any defective products will be limited to the repair or replacement of such products. In no event shall ZIGEN be responsible or liable for any damage arising from the use of such defective products whether such damages be direct, indirect, consequential or otherwise, and whether such damages are incurred by the reseller, end-user or any third party. The information in this manual has been carefully checked and is believed to be accurate. However, ZIGEN assumes no responsibility for any inaccuracies that may be contained in this manual, even if advised of the possibility of such damages. The technical information contained herein regarding the features and specifications is subject to change without notice.